

## *Installation Manual*

### CATSwitch

16-port HDTV CAT5 Matrix Switch  
with RS-232, IR, USB, and TCP/IP Control



For WUXGA, Component Video, Composite Video and  
S-Video with full stereo audio matrix switching  
Switch up to 16 remote devices to 16 remote displays  
located up to 1,000 feet away.

## **Introduction**

CATSwitch routes audio and video signals from several different video sources out to multiple displays (projectors, monitors, etc.) and speakers via inexpensive Cat5/6 UTP cable.

CATSwitch is capable of connecting to as many as 16 video sources via transmitters and 16 video displays via receivers with a maximum extension of 1,000 feet between the transmitter and receiver units.

A single audio/video output can be routed to one or multiple destinations. Video is transmitted at a resolution of 1920 x 1200 to insure high resolution images. Buffered video outputs and analog delivery of stereo audio maintains optimum integrity throughout the system. Special remote boxes offer compatibility with Video Composite , UXGA, Component Video and S-Video.

## **Features**

- Supports high resolution video up to 1920x1200
- High quality audio switching
- Infrared, RS232 and TCP/IP control
- PC Windows software control
- Integral UTP distribution
- 1U rackmounted chassis
- Uses easy to install, inexpensive CAT-5/5e/6/7/8
- Maximum extension of 1,000 feet (500m) between the local and remote units
- HDTV compatible. (720p, 1080i,1080p)
- 300 MHz bandwidth
- Compatible with VGA, XGA, Sun, MAC and SGI
- Sync Format / Polarity Preservation
- Compatible with Line Level Stereo Audio Signals
- High ground loop immunity
- Built-in power surge and transient protection
- Designated trimmer in the remote unit to compensate for length

CATSwitch Rear



# Ordering Information

Part Number	Description
CSW08X08S	CAT5 Matrix audio/video 8x8 matrix with RS232 control. Includes: [CSW08X08 (SM-CSW) and (CCPWR06US) or (CCPWR06EU)]
CSW16X08S	CAT5 Matrix audio/video 16x8 matrix with RS232 control. Includes: [CSW16X08 (SM-CSW) and (CCPWR06US) or (CCPWR06EU)]
CSW16X16S	CAT5 Matrix audio/video 16x16 matrix with RS232 control. Includes: [CSW16X16 (SM-CSW) and (CCPWR06US) or (CCPWR06EU)]
CSWP08X08S	CAT5 Matrix audio/video/IR and R232 8x8 matrix with RS232 control. Includes: [CSWP08X08 (SM-CSW) and (CCPWR06US) or (CCPWR06EU)]
CSWP16X08S	CAT5 Matrix audio/video/IR and R232 16x8 matrix with RS232 control. Includes: [CSWP16X08 (SM-CSW) and (CCPWR06US) or (CCPWR06EU)]
CSWP16X16S	CAT5 Matrix audio/video/IR and R232 16x16 matrix with RS232 control. Includes: [CSWP16X16 (SM-CSW) and (CCPWR06US) or (CCPWR06EU)]

Part Number	Receivers and Accessories
XTP-TXS	XTPRO UXGA/Audio/RS232/IR transmitter with Local Video . Includes:[ XTP-RX and (PS5VD2A)]
XTP-RXS	XTPRO UXGA/Audio/RS232/IR receiver with Dual Video Includes:[ XTP-RX and (PS5VD2A)]
XTP-RXLS	UXGA/Audio/RS232/IR Long Range receiver. Includes:[ XTP-RXL and (PS5VD2A)]
XTX-RXS	XT Xpress UXGA/Audio receiver. Includes:[ XTJ-RX and (PS5VD2A)]
XTJ-TXS	XT UXGA/Audio transmitter. Includes:[ XTJ-RX and (PS5VD2A)]
SM-TCPS	TCP/IP Control include SMTCP, (CCRS232MM ) and (PS5VD2A)]
SM-EYE	External infrared receiver. IR range of 10' to 30'
RMT-2	Remote control device
XTP-RXXS	Xtreem UXGA/Audio/RS-232/IR CAT5 1699ft Receiver with Remote Control for Skew Setting. Includes: [XTP-RXX, SMRMT, & (PS5VD2A)]

# Technical Specifications

VIDEO	
Bandwidth	250MHz
Input Signal Level	1 Volt pk pk into 75R
Output Impedance	100 Ohms
Input Impedance	75 Ohms
Connector	RJ45
Format	VGA/SVGA/XGA/WUXGA/RGB/Hv/RGsb
AUDIO	
Bandwidth	20KHz
Signal Level	0dB
Output Impedance	100 Ohms
Input Impedance	10K Ohms
Connector	RJ45
CONTROL	
RS232	Via Software @ 9600 bps
IR	Via Remote Control with IR-EYE Type 3
USB	Via TCP/IP (optional)
OTHER	
Power	Internal 100-240 VAC
Dimensions	17"W x 1.75"H (1U) x 8"D
Weight	4 lbs.
Approvals	UL, CE, ROHS Compliant
Operating Temp.	32-131°F (0-55 °C)
Storage Temp.	-4-185 °F (-20-85 °C)
Humidity	Up to 95%

# Applications

- Corporate or Educational Presentations
- Financial (Remote Servers/User Control)
- Call Centers for Technical Support
- Industrial (Long-Range Workstation Isolation)
- Airport Installations (Air Traffic Control/Passenger Information)
- KVM Extension where Exceptional Quality of Signal is Crucial
- Medical (Remote Operation Away from Sensitive/Magnetic Equipment)
- Recording (for Large Studios where Editing/Mixing Stations are Compact and/or Require Complete Silence)

# Application Diagram

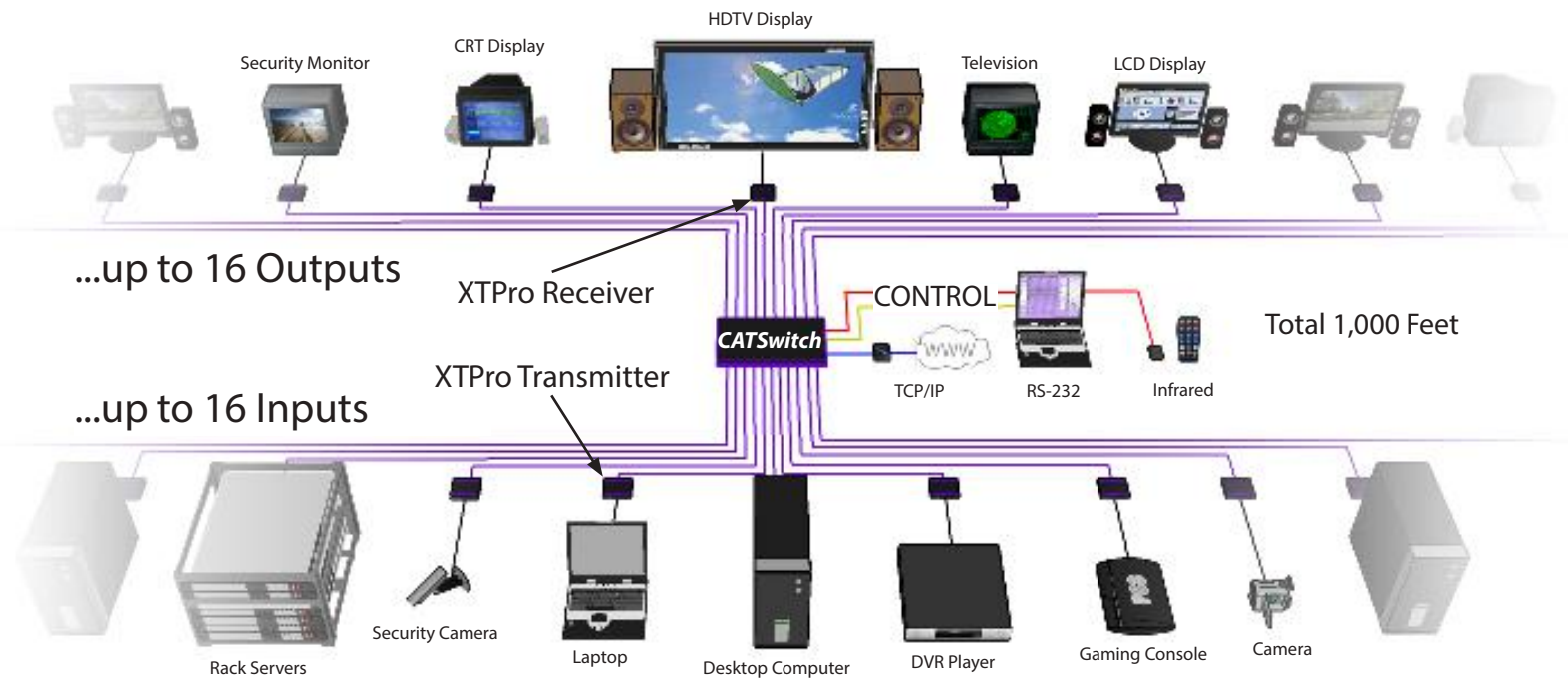

# Installation

## Connecting XTAV transmitter

### Connecting The Transmitter

1. Connect the output of the computer video card to the video input of the transmitter using the included male to male video cable.
2. Connect the output of the computer audio card to the audio input of the transmitter using 3.5mm audio male to male audio cable.
3. Connect external speakers to the transmitter's audio out (Standard 3.5mm stereo miniplug).
4. In the back of the unit connect the CAT5 cable that will connect to the receiver (XTAV-RX).

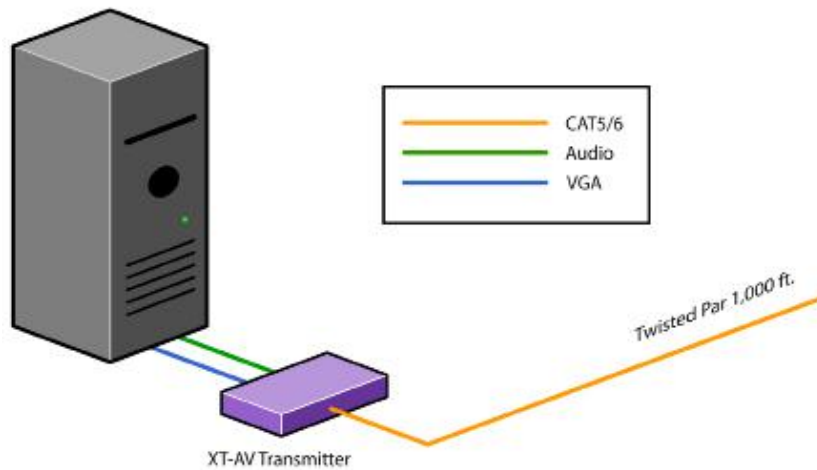

## Connecting the XTAV receiver

### Connecting The Receiver

1. Connect CAT5 cable (coming from the transmitter) to the back of the receiver.
2. Connect display monitors to the VGA out connector on the front of the receiver.
3. Connect external speakers to the audio output connections on the front of the unit. (Standard 3.5mm stereo Miniplug)

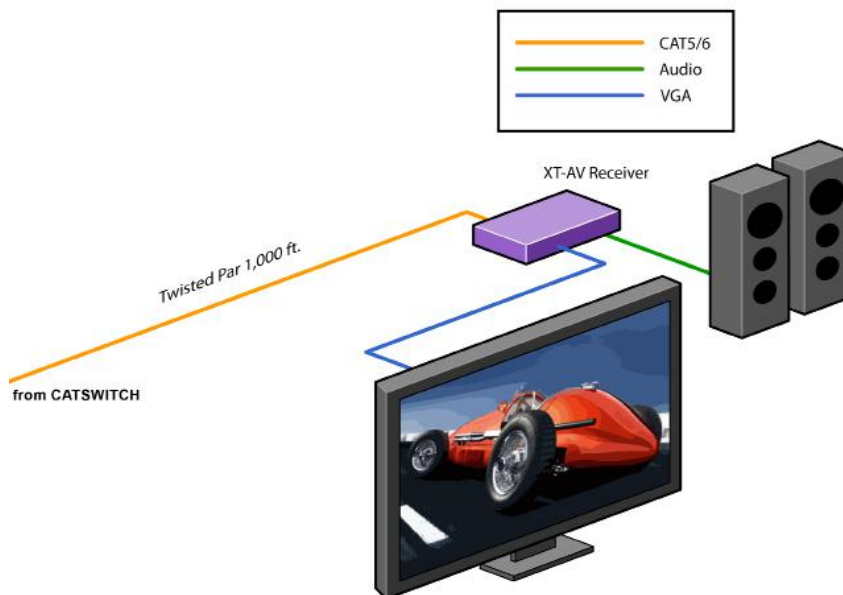

## Adjusting and Tuning the Signal

In order to fine tune the signal, adjust the individual dials one at a time starting with GREEN, then BLUE, and lastly RED. As you turn the dials you will notice the colors slightly change as you increase or decrease the strength. All dials should be around the same distance



## Installation (continued)

### Connecting XTWALL Transmitter

#### Connecting The Transmitter

1. Connect the output of the computer video card to the video input of the transmitter using the included male to male video cable.
2. Connect the output of the computer audio card to the audio input of the transmitter using 3.5mm audio male to male audio cable.
3. Connect local monitor to the VGA out of the transmitter.
4. Connect external speakers to the transmitter's audio out (Standard 3.5mm stereo miniplug).
5. In the back of the unit connect the CAT5 cable that will connect to the receiver (XTW-RX).

\*NOTE: You can not use RS232 and IR at the same time.

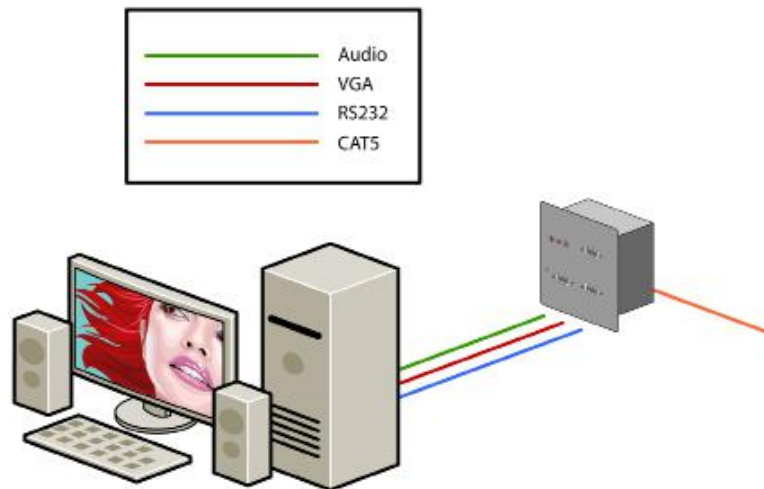

### Connecting XTWALL Receiver

#### Connecting The Receiver

1. Connect CAT5 cable (coming from the transmitter) to the back of the receiver.
2. Connect 1-2 display monitors to the VGA out connectors on the front of the receiver.
3. Connect 1-2 sets of external speakers to the audio output connections on the front of the unit. (Standard 3.5mm stereo Miniplug)

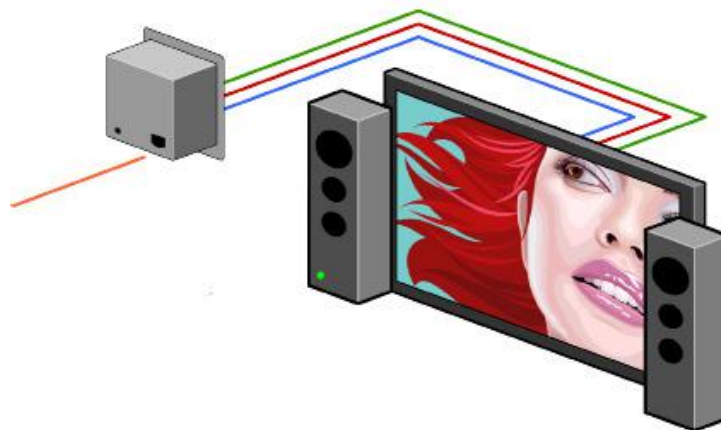

### Adjusting and Tuning the Signal

In order to fine tune the signal, adjust the individual dials one at a time starting with GREEN, then BLUE, and lastly RED. As you turn the dials you will notice the colors slightly change as you increase or decrease the strength. All dials should be around the same distance



## Installation (continued)

### Connecting the XTPro transmitter

#### Connecting The Transmitter

1. Connect the output of the computer video card to the video input of the transmitter using the included male to male video cable.
2. Connect the output of the computer audio card to the audio input of the transmitter using 3.5mm audio male to male audio cable.
3. Connect local monitor to the VGA out of the transmitter.
4. Connect external speakers to the transmitter's audio out (Standard 3.5mm stereo miniplug).
5. In the back of the unit connect the CAT5 cable that will connect to the receiver (XTPRO-RX). \*NOTE: You can not use RS232 and IR at the same time.

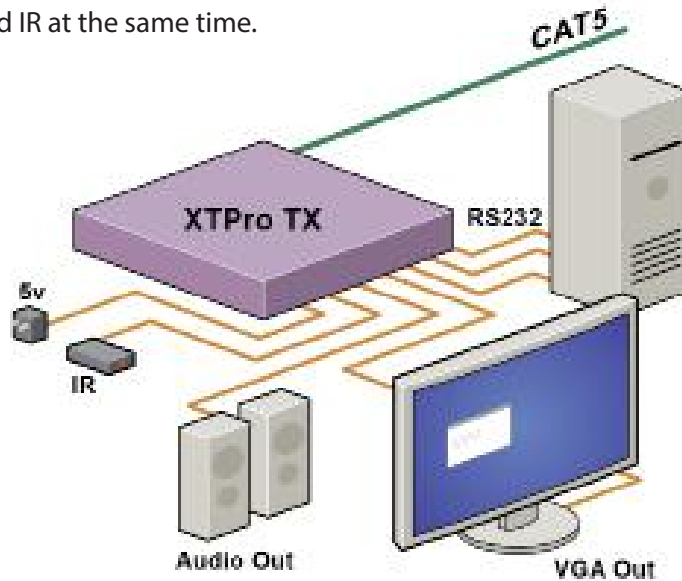

### Connecting the XTPro receiver

#### Connecting The Receiver

1. Connect CAT5 cable (coming from the transmitter) to the back of the receiver.
2. Connect 1-2 display monitors to the VGA out connectors on the front of the receiver.
3. Connect 1-2 sets of external speakers to the audio output connections on the front of the unit. (Standard 3.5mm stereo Miniplug)

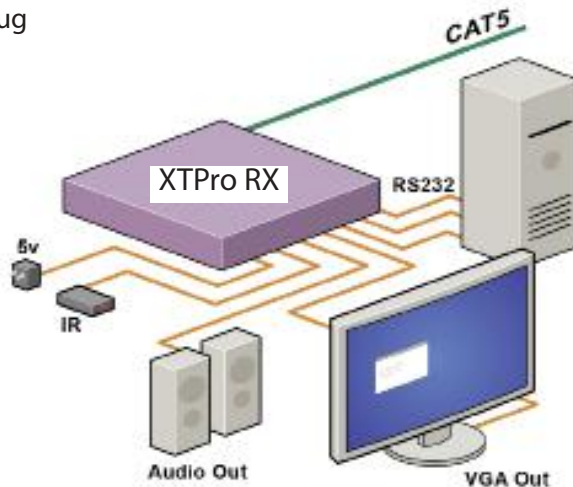

### Adjusting and Tuning the Signal

In order to fine tune the signal, adjust the individual dials one at a time starting with GREEN, then BLUE, and lastly RED. As you turn the dials you will notice the colors slightly change as you increase or decrease the strength. All dials should be around the same distance.

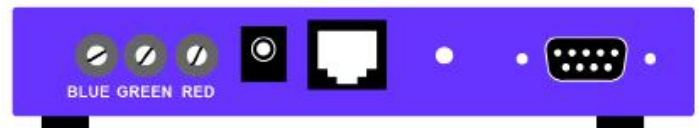

## Installation (continued)

### Connecting the XTPro-XTREEM receiver

#### Connecting The Receiver

1. Connect CAT5 cable (coming from the transmitter) to the back of the receiver.
2. Connect a display monitor to the VGA out connectors on the front of the receiver.
3. Connect a set of external speakers to the audio output connections on the front of the unit. (Standard 3.5mm stereo Miniplug)

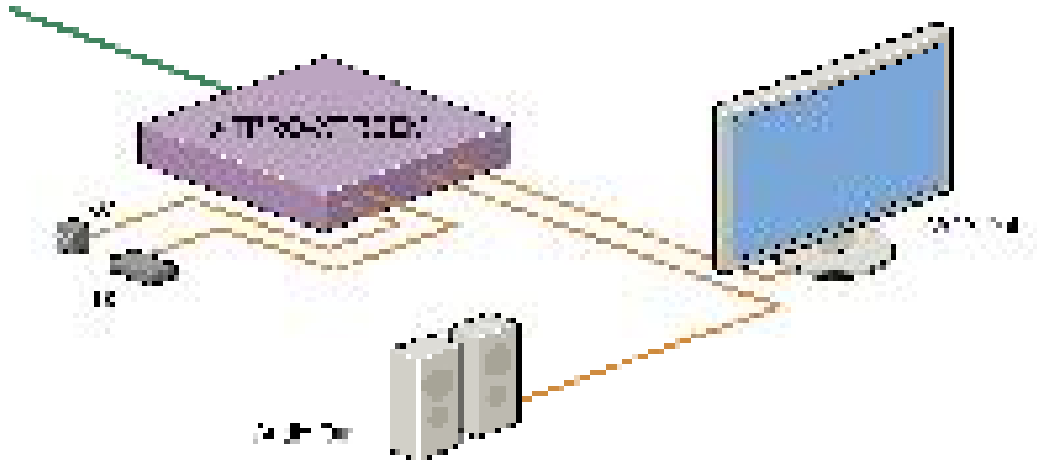

#### Adjusting and Tuning the Signal

In order to fine tune the signal, adjust the individual dials one at a time starting with GREEN, then BLUE, and lastly RED. As you turn the dials you will notice the colors slightly change as you increase or decrease the strength. All dials should be around the same distance.





## Installation (continued)

### Connecting the matrix

Now you are ready to connect the CATSwitch,

Connect all the cat5 coming from the transmitters to the inputs of the CATSwitch

Connect all the cat5 going to the receivers to the output

### Connecting the the main unit, the CATSwitch

Make sure the unit is powered off before connecting all the cables

#### Connecting all the Transmitters

- 1 Locate the RJ45 jacks on the back of the CATSwitch,
- 2 Connect the CAT5 cable to the RJ45 and mark each cable with the number of the transmitter
- 3 REPEAT steps for all transmitters cables

#### Connecting all the receivers

- 1 Locate the RJ45 jacks on the back of the catswitch,
- 2 Connect the CAT5 cable to the RJ45 and mark each cable with the number of the receivers
- 3 REPEAT steps for all receivers cables

After all connection are made, you can turn on the catswitch, on the front on the units 2 leds will show normal operation of the unit

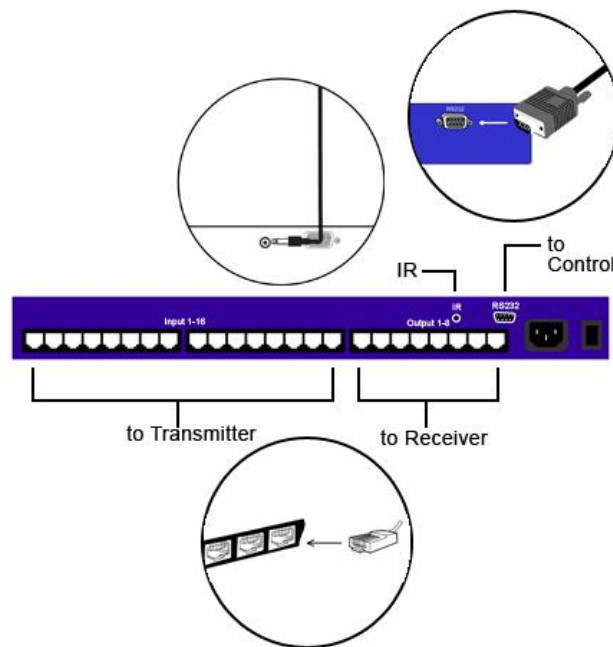

### Connecting the Control Communication Cable: RS-232

Each unit can be controlled by a RS-232 port connected from the back of the chassis. The SmartControlPro software will be used to control the units.

1. Connect the RS-232 cable the control computer by connecting the female RS-232 connector into the male RS-232 connector of the PC. Turn the side screws so that it does not accidentally become disconnected
2. Connect RS-232 cable connector to the male RS-232 connector on the back of the chassis.

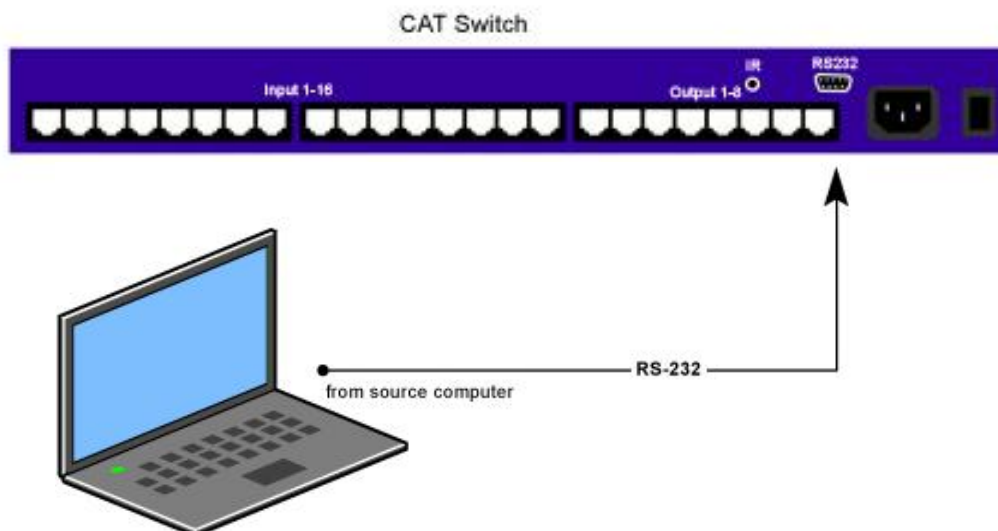

## Installation (continued)

### CAT5 Preparation

The CATSwitch is a point to point video extender/switcher. The system does not allow to connecting the Cat5 via hubs or any kind of switches that the point to point connection need be maintained. The 16 RJ45 ports on the front of the CATSwitch are output ports, providing connectivity to the XTPro or XT-AV receiver. This is a standard RJ45 connector, the CATSwitch can be connected via either CAT5, CAT5e or CAT6 cabling.

#### CAT5/5e/6 CABLE SPECIFICATIONS

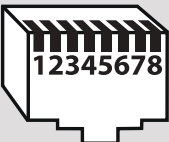
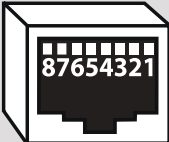
CONNECTOR		PAIR	PINS
RJ-45 MALE 	RJ-45 FEMALE 	1	1 & 2
		2	3 & 6
		3	4 & 5
		4	7 & 8
<b>CAPACITANCE</b>	14 pf/ft (46.2 pf/m)		
<b>CONDUCTOR GAUGE</b>	24 AWG		
<b>IMPEDANCE</b>	100 +/- 15 ohms		

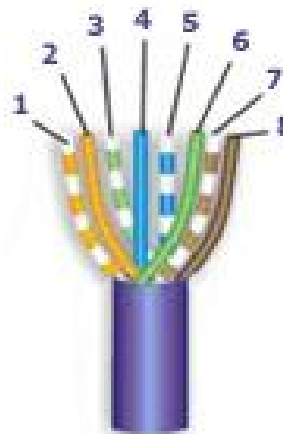

SmartAVI Proprietary Connector			
Pair	Color	RJ45 Pin	Description
1	White/Orange	1	Video+Audio
	Orange	2	
2	White/Green	3	Video+Audio
	Green	6	
3	Blue	4	Video+Audio
	White/Blue	5	
4	White/Brown	7	DATA RS232 and IR Bidirectional
	Brown	8	

# Software Operation

Find the Installation CD that came with your CATSWITCH unit. This CD has the SmartControlPro software that you will need in order to control the unit using a computer.

Insert the CD into your CD-ROM. On the CD you should see:

- SmartControl Pro Installer.exe
- SmartControl Pro Help File
- CATSWITCH Manual in PDF format

Double click SmartControlPro.exe in order to initiate software installation. Click Install. After installation has completed, click CLOSE.

In order to use the software, click on the START button>Programs>SmartControl Pro. There you should see a help file, the SmartControl Pro launcher as well as a shortcut to uninstall SmartControl Pro. Click on SmartControl Pro in order to launch the software.

When the software starts you will see a screen like this.

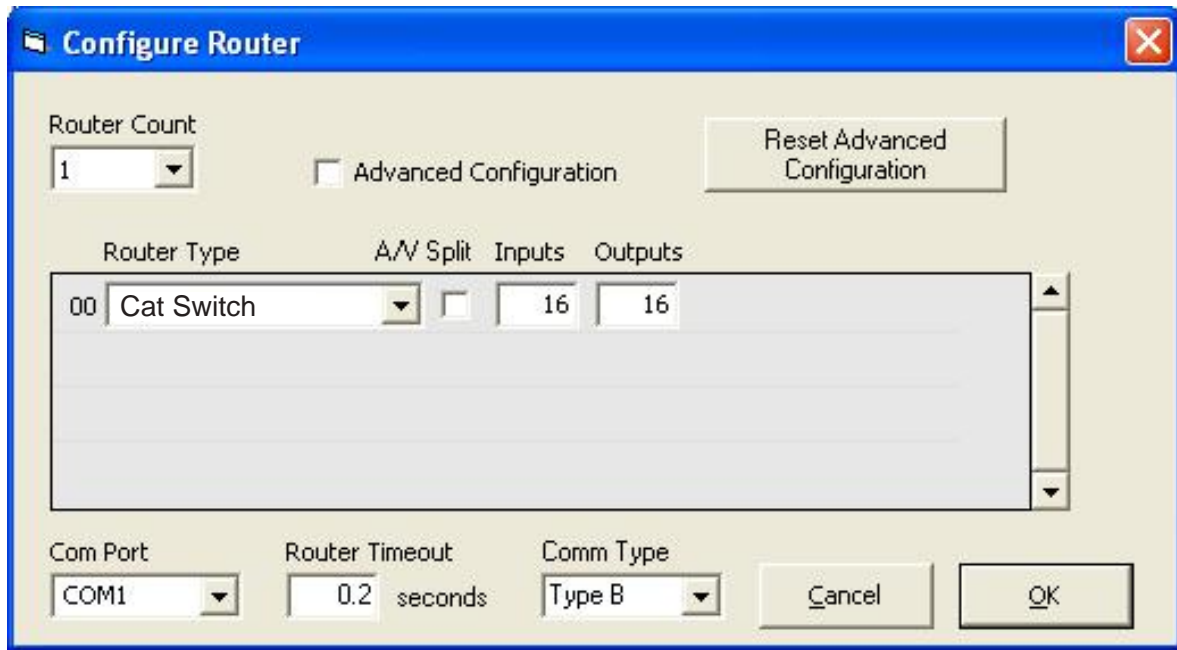

**Advanced Configuration:** If you have more than one Router installed you will want to check this box.

**Router Type:** Select "CATSWITCH"

**A/V Split:** Check this box if you need to route audio and video independently, regardless from which source they originated from. Leave unchecked if you want audio and video signals from the same input to remain together.

For example, if you wanted to route different video feeds to different locations but wanted all of them to have the same audio, you should check the box.

## Software Operation (continued)

- Inputs/Outputs:** Enter the number of Inputs/Outputs your CATSWITCH has. For now we will assume that there are 16 inputs and 16 outputs.
- Com Port:** Select the appropriate com port that your computer is using to access the router.
- Router Time out:** By default this is 0 meaning the computer acknowledges commands almost instantly. Sometimes a computer takes longer to respond. This setting should be left at 0. If you need to change it, it should be no higher than 0.2.

After you have entered in the necessary information click OK. This will now take you to the Main Routing Window where you can route the different video/audio connections.

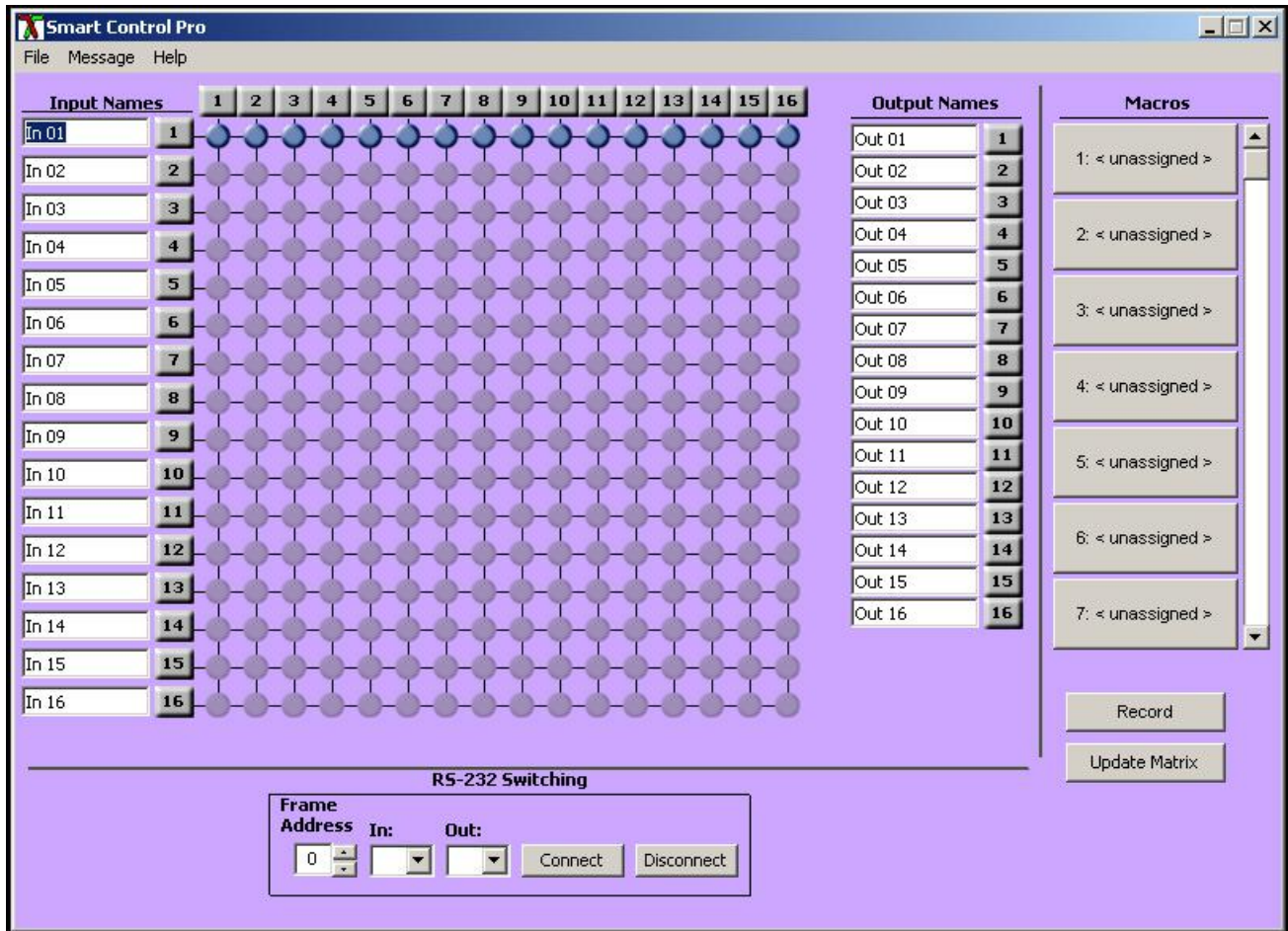

On this screen you will notice the input buttons running down the left side while the output buttons run across the top. They are each labeled 1 through 16.

Note: The three small colored buttons at the lower right labeled ALL, VIDEO, and AUDIO are not available if AV Split was not checked when you configured your router.

# Software Operation (continued)

The Main Routing Window enables you to control the router(s) connections by means of the CATSWITCH panel, the button panel, or with pre-recorded routes called macros.

CATSWITCH Panel: This is probably the simplest way to route the connections. Simply click on the cross point itself. The input on the left will then be routed to the output above.

Note: Inputs can be routed to several different outputs, but each output can only have a single input at any one time. So you can have several connections horizontally but not vertically.

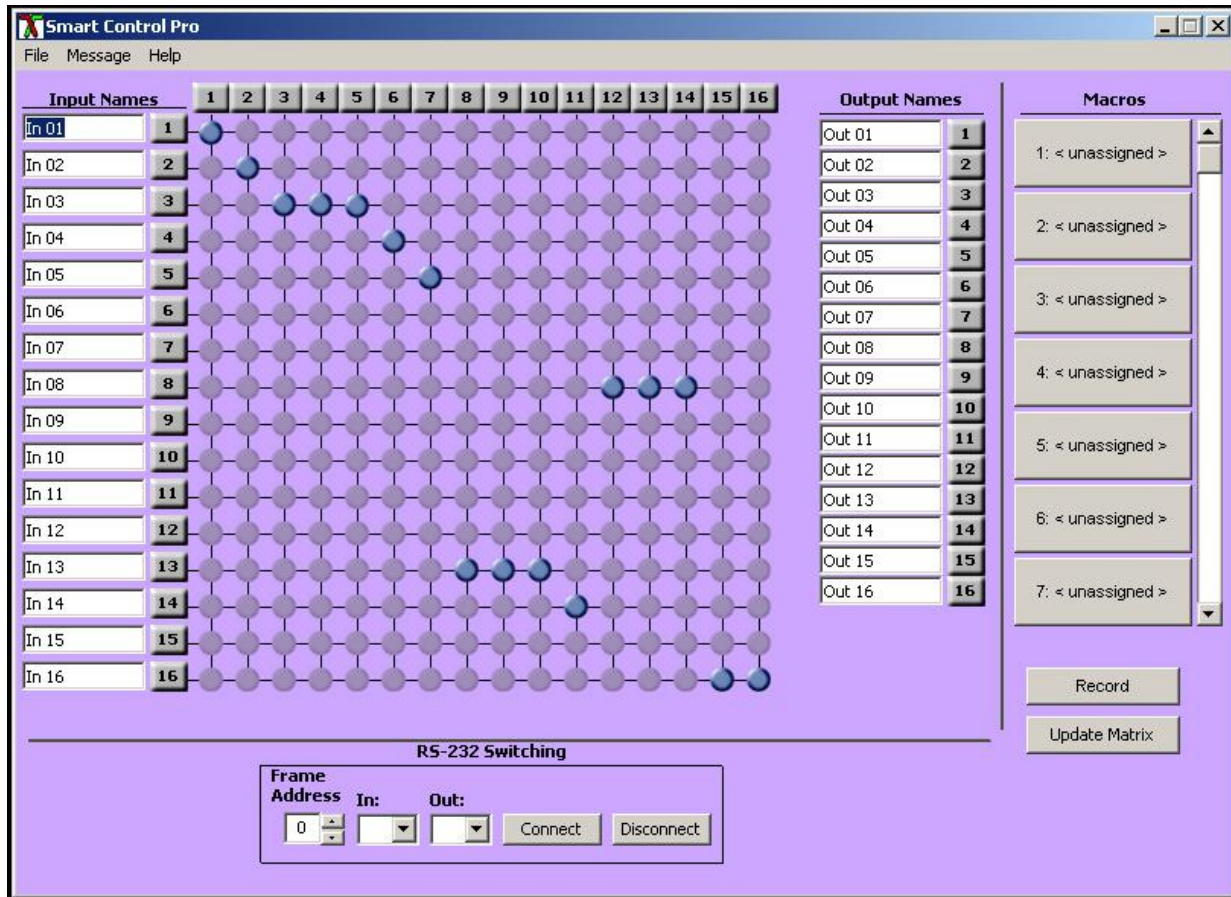

The Button Panel: These are the numbered buttons across the top and left sides. Click an output button on the top, and then click an input button on the left.

## Options for using the Button Panel

- **Output Options:**  
To select multiple outputs next to each other, click on one output, then hold the shift key down and click the last output. When the input is clicked, it is routed to all selected outputs.

To select multiple outputs individually, hold the control key down and click on any number of outputs. When the input is clicked, it is routed to all selected outputs.

- **Input Options:**  
To route an input to all the outputs at once, hold the control key down and click on an input.

To leave the outputs selected after the route is made, hold the shift key down and click on an input.

## Software Operation (continued)

Macros: This section of the window is used to save and play back macros. Macros store a set sequence of routes. To record a macro:

1. Click on the Record button (last button shown above). A blinking "recording" message below this button will be displayed to indicate that all routes are being recorded.
2. Select the desired cross points. (See CATSWITCH Routing for details on making these routes.) There is no limit on the number of routes you may record.
3. If you click a macro button while in the record mode, the macro will be executed, and these routes will be added to the recording. This makes it possible to combine the routes of two or more macros into one bigger macro.
4. When finished, click the "Save Macro" button. You will be instructed to then click on one of the macro buttons. Doing this will save the recorded routes to that button.

To cancel saving the macro, click the "Cancel Save" button.

5. To play back a macro, simply click on one of the 50 macro buttons. Use the scroll bar to bring any of these into view.
6. The macros are automatically saved in the current configuration file. They are also saved when you select the File/Save Configuration... menu.

To save macros in a separate file for a special purpose, select the File/Save Macros...menu.

## Software Operation (continued)

### Controlling with IR

#### Switching Ports with Remote Control

You have the option of controlling the CATSWITCH via Remote Control. The remote is used to control the CATSWITCH. The SM-EYE must be connected to the CATSWITCH ( this is an optional connector not always available in all boxes) in order to interface the remote control with the matrix. The way the remote control the matrix is as follows:

Xx<enter>yy<enter>

When XX is the output , YY is the input

To change the routing of the signals,

For example, to set output 3 to input 2 press "0" + "3" + ENTER, then press "0" + "2" + ENTER. If a wrong button is pressed, the user must either press the ESC button or wait 5 seconds before restarting the sequence.



## Controlling the CATSwitch with the SMTCP module

The SMTCP-2 is an RS-232 control module that allows most SmartAVI switching matrixes to be controlled remotely via HTTP or TELNET. Manage the switching functions of your matrix with ease from anywhere in the world. With the SMTCP-2 you can save up to 10 preset input/output configurations for easy access. TELNET access provides transparent command control of your matrix, perfect for use with automated third-party control software.

### Features

- Supports HTTP and TELNET control
- 10/100 Ethernet Interface
- Up to 10 user-definable configurations
- Password Protected
- Up to 5 Users can Control the Matrixes
- IP Configuration via TCP/IP and RS-232
- Flexible control of several types of matrixes

### Applications

- Server Collocation
- Digital Signage
- Airports
- Dealer Rooms
- Control Rooms
- Audio/Visual Presentations
- Hotels/Resorts
- KVM Switches

### **Technical Specifications**

Power	External 100-240 VAC/5VDC2A @10W
Dimensions	2.8125"W x 1"H x 3.375"D
Weight	0.5 lbs
Approvals	UL, CE, ROHS Compliant
Operating Temp.	32-131°F (0-55 °C)
Storage Temp.	-4-185 °F (-20-85 °C)
Humidity	Up to 95%



# Controlling the CATSwitch with the SMTCP module (continued)

## Connecting to the SMTCP-2 for the first time

The first time you connect the SMTCP-2, you will need to perform the following steps to set the initial configuration. This includes establishing an HTTP connection and manually setting the IP address for the SMTCP-2.

1. Power off all devices.

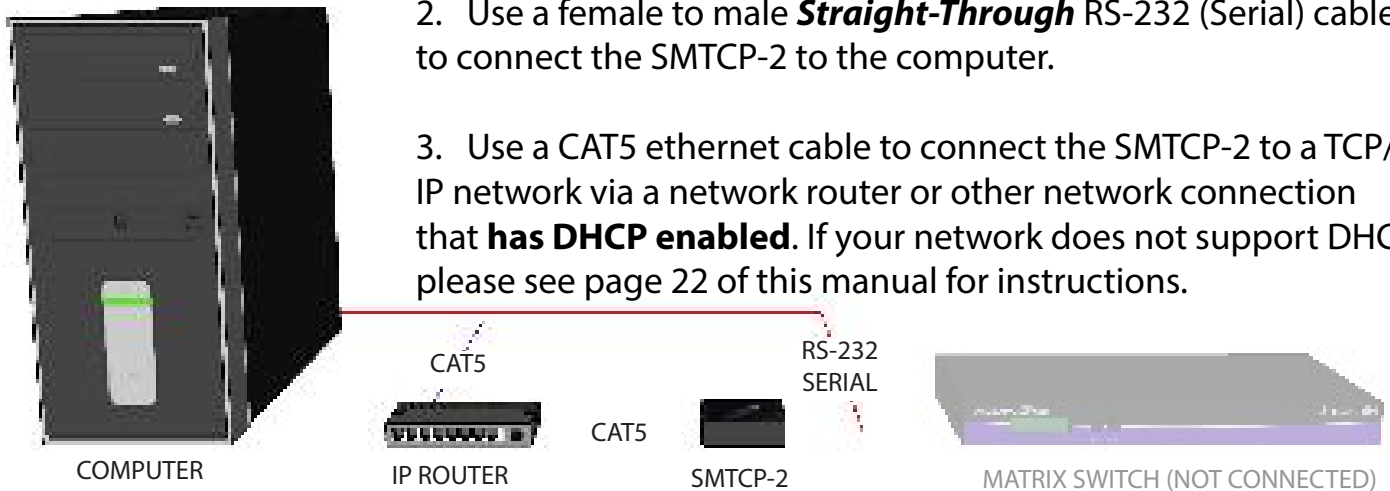

2. Use a female to male ***Straight-Through*** RS-232 (Serial) cable to connect the SMTCP-2 to the computer.

3. Use a CAT5 ethernet cable to connect the SMTCP-2 to a TCP/IP network via a network router or other network connection that **has DHCP enabled**. If your network does not support DHCP, please see page 22 of this manual for instructions.

4. Power on the computer and run a terminal program such as Hyperterminal to open a serial connection to the SMTCP-2 using the standard 9600 baud, 8, N, 1 configuration.
5. Power on the SMTCP-2. When powered on, it will obtain an IP address automatically via DHCP from the network.
6. The IP information for the SMTCP-2 will be displayed on the terminal screen as follows:

```
*****  
* SmartAVI control is UP *  
*   version 10.12.20#6   *  
*****  
  
addr:192.168.1.102  
Mask:255.255.255.0  
gtwy:192.168.1.1  
  
*****
```

*NOTE: the above IP address is for demonstration purposes only. Actual results may be different.*

7. The IP address shown must be used to connect to the SMTCP via HTTP.

## Controlling the CATSwitch with the SMTCP module (continued)

8. Open a web browser and navigate to the IP address that is indicated. You will be prompted to enter a username and password.

User ID:	Admin
Password:	••••
<input type="button" value="Click here to continue"/>	

9. The default login (case sensitive) is as follows:

**User ID: Admin**

**Password: Pass**

10. Once connected to the SMTCP-2, you will see the following menu of options:



1. Matrix
2. Frame Address
3. Device Config
4. Network Setting
5. User Administration

For the initial setup, click the **Network Setting** button and manually assign an IP address to the SMTCP-2. This will assure that the SMTCP-2 will always have the same IP address. Be sure to choose an address that will not conflict with any other devices on the network, and that the address is not in the range of the DHCP server.

Network Configuration:	
Use DHCP:	<input checked="" type="checkbox"/>
IP Address:	<input type="text"/>
IP Mask:	<input type="text"/>
Gateway:	<input type="text"/>
<input type="button" value="Submit"/>	



COMPUTER



IP ROUTER

CAT5



SMTCP-2

RS-232  
SERIAL



MATRIX SWITCH

11. Once you have manually assigned an IP address to the SMTCP-2, you may disconnect the **Straight-Through** RS-232 (Serial) cable from the computer

12. Connect the SMTCP-2 to the matrix switch with a **Cross** RS-232 (Serial) cable.

It is also recommended that you set a password for the SMTCP-2 at this point. To set the password (and/or username), click on the **User Administration** button, enter the password and click *Submit*. This sets the password for the HTTP interface only.

## Controlling the CATSwitch with the SMTCP module (continued)

### Controlling the SMTCP-2 via HTTP

Once you have completed the Initial Setup for the SMTCP-2, you can now begin configuring it for your matrix. The following details the individual menu options in the web interface:

#### ***Matrix Menu***

The screenshot shows two parts of the Matrix Menu interface. On the left is a crosspoint matrix with 8 inputs and 8 outputs. The inputs are labeled 1 through 8, and the outputs are labeled 1 through 8. The matrix cells contain radio buttons, some of which are checked to indicate connections. On the right is a 'Matrix Preset' section with a list of 10 presets, each with a 'SAVE' button next to it.

		Outputs:							
		1	2	3	4	5	6	7	8
Inputs:	1	<input type="radio"/>	<input type="radio"/>	<input checked="" type="radio"/>	<input checked="" type="radio"/>	<input checked="" type="radio"/>	<input type="radio"/>	<input type="radio"/>	<input type="radio"/>
	this	<input type="radio"/>	<input type="radio"/>	<input type="radio"/>	<input type="radio"/>	<input type="radio"/>	<input checked="" type="radio"/>	<input checked="" type="radio"/>	<input checked="" type="radio"/>
	is	<input type="radio"/>	<input type="radio"/>	<input type="radio"/>	<input type="radio"/>	<input type="radio"/>	<input type="radio"/>	<input type="radio"/>	<input type="radio"/>
	a	<input type="radio"/>	<input type="radio"/>	<input type="radio"/>	<input type="radio"/>	<input type="radio"/>	<input type="radio"/>	<input type="radio"/>	<input type="radio"/>
	test	<input checked="" type="radio"/>	<input type="radio"/>	<input type="radio"/>	<input type="radio"/>	<input type="radio"/>	<input type="radio"/>	<input type="radio"/>	<input type="radio"/>
	6	<input type="radio"/>	<input checked="" type="radio"/>	<input type="radio"/>	<input type="radio"/>	<input type="radio"/>	<input type="radio"/>	<input type="radio"/>	<input type="radio"/>
	7	<input type="radio"/>	<input type="radio"/>	<input type="radio"/>	<input type="radio"/>	<input type="radio"/>	<input type="radio"/>	<input type="radio"/>	<input type="radio"/>
	8	<input type="radio"/>	<input type="radio"/>	<input type="radio"/>	<input type="radio"/>	<input type="radio"/>	<input type="radio"/>	<input type="radio"/>	<input type="radio"/>

Matrix Preset	
This is a test	SAVE
2	SAVE
This is another	SAVE
4	SAVE
6	SAVE
8	SAVE
10	SAVE

The matrix menu allows you to set the crosspoints for the matrix. Crosspoints are used to route signals from the individual inputs to individual outputs. The output channels can only have one input, but each input can have several outputs.

Example shown in diagram:

*Input 1 to Outputs 3,4,5*

*Input **this** to Outputs 6,7,8*

*Input **test** to Output 1*

*Input 6 to Output 2*

The Matrix Preset option allows you to save and recall crosspoint configurations with the push of a button. To save a preset, simply configure your crosspoints and press the SAVE button next to the desired preset. To recall a preset, simply click on the button with its name. To edit the preset names, see the ***Device Config*** menu.

#### ***Frame Address Menu***

The screenshot shows the Frame Address Menu interface with three input fields and a Submit button. The first field is labeled 'Frame Address:', the second 'Current Address:' with a value of 0, and the third 'Change Current to:' with a value of 0.

Frame Address:	
Current Address:	0
Change Current to:	0
Submit	

The frame address menu allows you to set the frame address of the current matrix switch. Frame addresses allow commands to be sent to different matrixes in series. For more information on the specific commands available, please see the instructions for your matrix switch.

# Controlling the CATSwitch with the SMTCP module (continued)

## Device Config Menu

Device Type:	Input Names:	Output Names:	Preset Names:
<input type="text" value="DVR 8x8"/>	1: <input type="text" value="1"/>	1: <input type="text" value="1"/>	1: <input type="text" value="This is a test"/>
	2: <input type="text" value="this"/>	2: <input type="text" value="2"/>	2: <input type="text" value="2"/>
Matrix dimensions:	3: <input type="text" value="is"/>	3: <input type="text" value="3"/>	3: <input type="text" value="This is another"/>
Inputs: <input type="text" value="8"/>	4: <input type="text" value="a"/>	4: <input type="text" value="4"/>	4: <input type="text" value="4"/>
Outputs: <input type="text" value="8"/>	5: <input type="text" value="test"/>	5: <input type="text" value="5"/>	5: <input type="text" value=""/>
<input type="button" value="Submit"/>	6: <input type="text" value="6"/>	6: <input type="text" value="6"/>	6: <input type="text" value="6"/>
<input type="button" value="Reset Names"/>	7: <input type="text" value="7"/>	7: <input type="text" value="7"/>	7: <input type="text" value=""/>
<input type="button" value="System Reset"/>	8: <input type="text" value="8"/>	8: <input type="text" value="8"/>	8: <input type="text" value="8"/>
			9: <input type="text" value=""/>
			10: <input type="text" value="10"/>

The device configuration menu allows you to select the type of matrix you are using, specify the dimensions of the matrix, and assign names to the inputs, outputs and presets, reset the names and reset the system to factory defaults.

To begin, set the type of device you are using from the drop-down menu labeled Device Type and specify the Matrix Dimensions. After specifying the Matrix Dimensions, press the Submit button to make the changes.

Once the type of matrix is entered, you can assign names to each of your inputs, outputs and presets. The preset names are used in the Matrix Menu for quick storage and retrieval of matrix configurations. Leaving a preset blank will exclude it from the Matrix Menu.

## Network Setting Menu

Network Configuration:	
Use DHCP:	<input checked="" type="checkbox"/>
IP Address:	<input type="text"/>
IP Mask:	<input type="text"/>
Gateway:	<input type="text"/>
<input type="button" value="Submit"/>	

The network setting menu allows you to assign a static IP address to the SMTCP-2. It is recommended that you statically assign an IP address to avoid any future conflict or connectivity issues with DHCP.

## Controlling the CATSwitch with the SMTCP module (continued)

### User Administration Menu

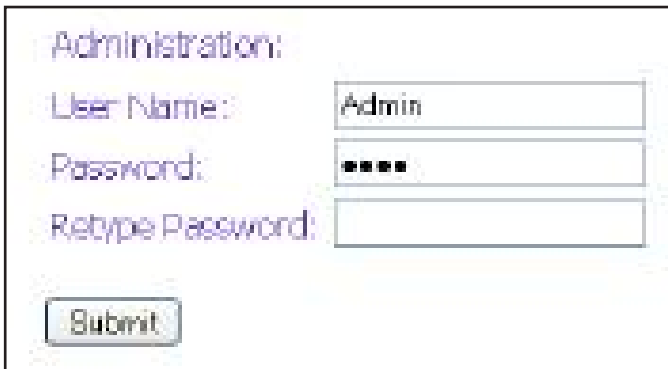

Administration:

User Name:

Password:

Retype Password:

The User Administration menu allows you to change the user name and password for the SMTCP-2. The default user name for the SMTCP-2 is Admin and the password is Pass. Once you modify the login information, press the Submit button to make the changes.

### Controlling the SMTCP-2 via TELNET

Commands may be sent transparently to the matrix via a TELNET connection to the SMTCP-2. To use this function, use a telnet client such as Hyperterminal or PuTTY to connect to the IP address of the SMTCP-2. You will be prompted for a username and password - this will be the same as the login information via HTTP. Once logged in, the SMTCP-2 is ready to accept the standard RS-232 commands. For a list of the available commands, please see the user manual for the matrix you are using. Although the commands are not echoed to the client display, the commands are being issued to the matrix. Should you need commands to be echoed, please see the instructions for your TELNET client.

### Upgrading the SMTCP-2

To upgrade the SMTCP-2 with the latest firmware, contact your sales representative to obtain the firmware upgrade file or visit the SMTCP-2 product page at [www.smartavi.com](http://www.smartavi.com). The version information is listed on the Main Menu. Once you have the file, use an FTP client, preferably TFTP, to navigate to the IP address of the SMTCP-2. To upload the file to the SMTCP-2, navigate to the /var/ directory, and upload the file **firmware.img** - **IMPORTANT: the file MUST BE NAMED firmware.img** for the upgrade to work properly. Again, the full path **MUST BE /var/firmware.img**. Once the file has been copied, restart (power off and power on) the SMTCP-2. Once restarted the firmware update will be installed. To verify the upgrade, see the version information listed on the Main Menu.

SMTCP-2 Front



SMTCP-2 Rear





# Technical Information

XTPRO SPECIFICATIONS	
<b>Receiver with local monitor, Audio and IR/RS-232 support</b>	
VGA Data	
Format	RGBHV, RGsB, YUV, Y/C, CVBS
Resolution	Up to 1900 x 1200 VGA, SVGA, XGA, SXGA
Connector Type	HD 15 socket
Audio	
Signal Type	Stereo unbalanced
Connector Type	3.5mm jack socket
Infrared	
Signal Type	30 to 110Khz
Connector Type	3.5mm socket
RS-232	
Speed	2400 to 115Kbps
Connector Type	DB9 Male
Power	
Requirements	5VDC @.5A
Connector	2.1mm DC jack (center +ve)
Physical	
Dimensions	135 x 90 x 23mm (26 with pegs)
Weight	.8 lbs or .36 kg

XTAV SPECIFICATIONS	
<b>Receiver with Video and Audio support</b>	
VGA Data	
Format	RGBHV, RGsB, YUV, Y/C, CVBS
Resolution	Up to 1900 x 1200 VGA, SVGA, XGA, SXGA
Connector type	HD 15 socket
Audio	
Signal Type	Stereo unbalanced
Connector	3.5mm jack socket
Power	
Requirements	5VDC @.5A
Connector	2.1mm DC jack (center +ve)
Physical	
Dimensions	90 x 90 x 23mm (26 with pegs)
Weight	.6 lbs or .36 kg



## Technical Information (continued)

XTProWALL	
VGA Data	
Format	RGBHV, RGsB, YUV, Y/C, CVBS
Resolution	Up to 1900 x 1200, VGA, SVGA, XGA, SXGA)
Connector Type	HD 15 socket
Audio	
Signal Type	Stereo unbalanced
Connector	3.5 mm jack socket
RS232	
	DB9M
	TXD, RXD, Gnd.
	9600 bps
Power	
Requirements	5VDC@.5A
Connector	2.1mm DC jack (center +ve)
Physical	
Dimensions	Face plate is 4.5" x 4.5
Weight	0.5 lbs





# RS-232 Specifications

How to properly create an RS-232 connection between a PC and most SmartAVI RS-232 compliant devices

## Establish a connection to your RS-232 compliant device:

1. Connect a straight through male to female RS-232 cable (shown on right) to the RS-232 connector on the PC.
2. Connect the other end of the cable to the RS-232 compliant device.
3. Power on the device.



Male to Female Straight Cable (not provided)



Hyperterminal Settings

## Setting up the Terminal application:

1. Open Hyperterminal on the PC. (or use the terminal client of your choice)
2. Use the default settings to create a connection to the device (see settings on left). Settings **MUST** match those shown on the lower right.
3. Be sure that Flow Control is **None**.
4. The output of the device will be the same as the PC.

## RS-232 Specifications (continued)

How to properly test an RS-232 connection between a PC and most SmartAVI RS-232 compliant devices

**After you have established a connection to your device use the following commands:**

1) To set a video crosspoint

**//FxxMyyIzz<CHK><CR>**

e.g. to set video input 3 to output 12 on a router with frame address 'D' send the command: **//F00M12I03<0x42><CR>**

2) To set RS-232 crosspoint

**//FxxRyyIzz<CHK><CR>**

3) To disconnect RS-232 crosspoint

**//FxxDyyIzz<CHK><CR>**

4) To set new frame address:

**//FxxFnn<CHK><CR>**

## ***IMPORTANT***

### **CALCULATING THE <CHK>**

<CHK> stands for CHECKSUM: the <CHK> value is calculated by performing an XOR of the full command string. For example: //F00M12I03 will XOR to the hexadecimal value 0x42, therefore the value of <CHK> is 0x42.

## RS-232 Specifications (continued)

How to properly test an RS-232 connection between a PC and most SmartAVI RS-232 compliant devices

### RS-232 Commands continued:

5) To query crosspoints from PC:

//ExxU<CHK><CR>

- If all outputs are connected to input 1 then a 4x4 Matrix will respond with <0x80><0x80><0x80><0x80><CR>
- The router will send back one byte for each output and the string ends with a <CR>. The first byte sent is Output #1. In the example above, since there are 5 bytes total, we know that there are 4 outputs.
- To calculate the input number, the router sends the input number with the 7<sup>th</sup> bit set.
  - 0x80 = "1000 0000" → input 0
  - 0x81 = "1000 0001" → input 1
  - ...
  - 0xBF = "1000 1111" → input 15

### Comms Port Settings:

<b>Baud Rate</b>	<b>9600</b>
<b>Start Bits</b>	<b>1</b>
<b>Data Bits</b>	<b>8</b>
<b>Parity</b>	<b>None</b>
<b>Stop Bits</b>	<b>1</b>

### Notes:

- When successful, commands #1-4 will acknowledge by sending the checksum with nibbles swapped & <CR><LF>
  - e.g. checksum of 0x24 acknowledges with <0x42><CR><LF>

## RS-232 Specifications (continued)

How to properly test an RS-232 connection between a PC and most SmartAVI RS-232 compliant devices

**The following are example commands for the first 8 inputs and 8 outputs. The hexadecimal values of the commands are also listed.**

<i>Operation</i>	<i>Command</i>	<i>Hexidecimal Value</i>
input_1_output_1	//F00M01101<CHK><CR>	2F 2F 46 30 30 4D 30 31 49 30 31 42 0D
input_2_output_1	//F00M01102<CHK><CR>	2F 2F 46 30 30 4D 30 31 49 30 32 41 0D
input_3_output_1	//F00M01103<CHK><CR>	2F 2F 46 30 30 4D 30 31 49 30 33 40 0D
input_4_output_1	//F00M01104<CHK><CR>	2F 2F 46 30 30 4D 30 31 49 30 34 47 0D
input_5_output_1	//F00M01105<CHK><CR>	2F 2F 46 30 30 4D 30 31 49 30 35 46 0D
input_6_output_1	//F00M01106<CHK><CR>	2F 2F 46 30 30 4D 30 31 49 30 36 45 0D
input_7_output_1	//F00M01107<CHK><CR>	2F 2F 46 30 30 4D 30 31 49 30 37 44 0D
input_8_output_1	//F00M01108<CHK><CR>	2F 2F 46 30 30 4D 30 31 49 30 38 4B 0D
input_1_output_2	//F00M02101<CHK><CR>	2F 2F 46 30 30 4D 30 32 49 30 31 41 0D
input_2_output_2	//F00M02102<CHK><CR>	2F 2F 46 30 30 4D 30 32 49 30 32 42 0D
input_3_output_2	//F00M02103<CHK><CR>	2F 2F 46 30 30 4D 30 32 49 30 33 43 0D
input_4_output_2	//F00M02104<CHK><CR>	2F 2F 46 30 30 4D 30 32 49 30 34 44 0D
input_5_output_2	//F00M02105<CHK><CR>	2F 2F 46 30 30 4D 30 32 49 30 35 45 0D
input_6_output_2	//F00M02106<CHK><CR>	2F 2F 46 30 30 4D 30 32 49 30 36 46 0D
input_7_output_2	//F00M02107<CHK><CR>	2F 2F 46 30 30 4D 30 32 49 30 37 47 0D
input_8_output_2	//F00M02108<CHK><CR>	2F 2F 46 30 30 4D 30 32 49 30 38 48 0D
input_1_output_3	//F00M03101<CHK><CR>	2F 2F 46 30 30 4D 30 33 49 30 31 40 0D
input_2_output_3	//F00M03102<CHK><CR>	2F 2F 46 30 30 4D 30 33 49 30 32 43 0D
input_3_output_3	//F00M03103<CHK><CR>	2F 2F 46 30 30 4D 30 33 49 30 33 42 0D
input_4_output_3	//F00M03104<CHK><CR>	2F 2F 46 30 30 4D 30 33 49 30 34 45 0D
input_5_output_3	//F00M03105<CHK><CR>	2F 2F 46 30 30 4D 30 33 49 30 35 44 0D
input_6_output_3	//F00M03106<CHK><CR>	2F 2F 46 30 30 4D 30 33 49 30 36 47 0D
input_7_output_3	//F00M03107<CHK><CR>	2F 2F 46 30 30 4D 30 33 49 30 37 46 0D
input_8_output_3	//F00M03108<CHK><CR>	2F 2F 46 30 30 4D 30 33 49 30 38 49 0D
input_1_output_4	//F00M04101<CHK><CR>	2F 2F 46 30 30 4D 30 34 49 30 31 47 0D
input_2_output_4	//F00M04102<CHK><CR>	2F 2F 46 30 30 4D 30 34 49 30 32 44 0D
input_3_output_4	//F00M04103<CHK><CR>	2F 2F 46 30 30 4D 30 34 49 30 33 45 0D
input_4_output_4	//F00M04104<CHK><CR>	2F 2F 46 30 30 4D 30 34 49 30 34 42 0D
input_5_output_4	//F00M04105<CHK><CR>	2F 2F 46 30 30 4D 30 34 49 30 35 43 0D
input_6_output_4	//F00M04106<CHK><CR>	2F 2F 46 30 30 4D 30 34 49 30 36 40 0D
input_7_output_4	//F00M04107<CHK><CR>	2F 2F 46 30 30 4D 30 34 49 30 37 41 0D
input_8_output_4	//F00M04108<CHK><CR>	2F 2F 46 30 30 4D 30 34 49 30 38 4E 0D
input_1_output_5	//F00M05101<CHK><CR>	2F 2F 46 30 30 4D 30 35 49 30 31 46 0D
input_2_output_5	//F00M05102<CHK><CR>	2F 2F 46 30 30 4D 30 35 49 30 32 45 0D
input_3_output_5	//F00M05103<CHK><CR>	2F 2F 46 30 30 4D 30 35 49 30 33 44 0D
input_4_output_5	//F00M05104<CHK><CR>	2F 2F 46 30 30 4D 30 35 49 30 34 43 0D
input_5_output_5	//F00M05105<CHK><CR>	2F 2F 46 30 30 4D 30 35 49 30 35 42 0D
input_6_output_5	//F00M05106<CHK><CR>	2F 2F 46 30 30 4D 30 35 49 30 36 41 0D
input_7_output_5	//F00M05107<CHK><CR>	2F 2F 46 30 30 4D 30 35 49 30 37 40 0D
input_8_output_5	//F00M05108<CHK><CR>	2F 2F 46 30 30 4D 30 35 49 30 38 4F 0D

## RS-232 Specifications (continued)

How to properly test an RS-232 connection between a PC and most SmartAVI RS-232 compliant devices

input_1_output_6	//F00M06101<CHK><CR>	2F2F4630304D3036493031450D
input_2_output_6	//F00M06102<CHK><CR>	2F2F4630304D3036493032460D
input_3_output_6	//F00M06103<CHK><CR>	2F2F4630304D3036493033470D
input_4_output_6	//F00M06104<CHK><CR>	2F2F4630304D3036493034400D
input_5_output_6	//F00M06105<CHK><CR>	2F2F4630304D3036493035410D
input_6_output_6	//F00M06106<CHK><CR>	2F2F4630304D3036493036420D
input_7_output_6	//F00M06107<CHK><CR>	2F2F4630304D3036493037430D
input_8_output_6	//F00M06108<CHK><CR>	2F2F4630304D30364930384F0D
input_1_output_7	//F00M07101<CHK><CR>	2F2F4630304D3037493031440D
input_2_output_7	//F00M07102<CHK><CR>	2F2F4630304D3037493032470D
input_3_output_7	//F00M07103<CHK><CR>	2F2F4630304D3037493033460D
input_4_output_7	//F00M07104<CHK><CR>	2F2F4630304D3037493034410D
input_5_output_7	//F00M07105<CHK><CR>	2F2F4630304D3037493035400D
input_6_output_7	//F00M07106<CHK><CR>	2F2F4630304D3037493036430D
input_7_output_7	//F00M07107<CHK><CR>	2F2F4630304D3037493037420D
input_8_output_7	//F00M07108<CHK><CR>	2F2F4630304D3037493038400D
input_1_output_8	//F00M08101<CHK><CR>	2F2F4630304D30384930314B0D
input_2_output_8	//F00M08102<CHK><CR>	2F2F4630304D3038493032480D
input_3_output_8	//F00M08103<CHK><CR>	2F2F4630304D3038493033490D
input_4_output_8	//F00M08104<CHK><CR>	2F2F4630304D30384930344E0D
input_5_output_8	//F00M08105<CHK><CR>	2F2F4630304D30384930354F0D
input_6_output_8	//F00M08106<CHK><CR>	2F2F4630304D30384930364C0D
input_7_output_8	//F00M08107<CHK><CR>	2F2F4630304D30384930374D0D
input_8_output_8	//F00M08108<CHK><CR>	2F2F4630304D3038493038420D
Query Current Matrix	//F00U<CHK><CR>	2F2F46303055130D

# RS-232 SPECIFICATION

How to properly test an RS-232 connection between a PC and most SmartAVI RS-232 compliant devices

## RS-232 SPECIFICATIONS

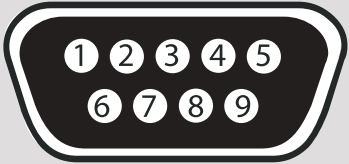
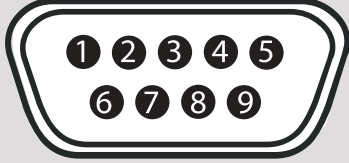
CONNECTOR	PIN	NAME	DESCRIPTION
DB9 MALE - RECEIVE 	2	RxD	Receive Data on DB9 Male
	3	TxD	Transmit Data on DB9 Male
	5	SGND	Ground
DB9 FEMALE - TRANSMIT 	2	TxD	Transmit Data on DB9 Female
	3	RxD	Receive Data on DB9 Female
	5	SGND	Ground

## Limited Warranty Statement

### A. Extent of limited warranty

1. SmartAVI Technologies, Inc. warrants to the end-user customers that the SmartAVI product specified above will be free from defects in materials and workmanship for the duration of 1 year, which duration begins on the date of purchase by the customer. Customer is responsible for maintaining proof of date of purchase.
2. SmartAVI limited warranty covers only those defects which arise as a result of normal use of the product, and do not apply to any:
  - a. Improper or inadequate maintenance or modifications
  - b. Operations outside product specifications
  - c. Mechanical abuse and exposure to severe conditions
3. If SmartAVI receives, during applicable warranty period, a notice of defect, SmartAVI will at its discretion replace or repair defective product . If SmartAVI is unable to replace or repair defective product covered by the SmartAVI warranty within reasonable period of time, SmartAVI shall refund the cost of the product.
4. SmartAVI shall have no obligation to repair, replace or refund unit until customer returns defective product to SmartAVI.
5. Any replacement product could be new or like new, provided that it has functionality at least equal to that of the product being replaced.
6. SmartAVI limited warranty is valid in any country where the covered product is distributed by SmartAVI.

### B. Limitations of warranty

TO THE EXTENT ALLOWED BY LOCAL LAW , NEITHER SMARTAVI NOR ITS THIRD PARTY SUPPLIERS MAKE ANY OTHER WARRANTY OR CONDITION OF ANY KIND WHETHER EXPRESSED OR IMPLIED , WITH RESPECT TO THE SMARTAVI PRODUCT , AND SPECIFICALLY DISCLAIM IMPLIED WARRANTIES OR CONDITIONS OF MERCHANTABILITY, SATISFACTORY QUALITY , AND FITNESS FOR A PARTICULAR PURPOSE

### C. Limitations of liability

To the extent allowed by local law the remedies provided in this warranty statement are the customers sole and exclusive remedies

TO THE EXTENT ALLOWED BY LOCAL LAW , EXCEPT FOR THE OBLIGATIONS SPECIFICALLY SET FORTH IN THIS WARRANTY STATEMENT , IN NO EVENT WILL SMARTAVI OR ITS THIRD PARTY SUPPLIERS BE LIABLE FOR DIRECT, INDIRECT, SPECIAL, INCIDENTAL, OR CONSEQUENTIAL DAMAGES WHETHER BASED ON CONTRACT , TORT OR ANY OTHER LEGAL THEORY , AND WHETHER ADVISED OF THE POSSIBILITY OF SUCH DAMAGES.

### D. Local law

To the extent that this warranty statement is inconsistent with local law, this warranty statement shall be considered modified to be consistent with such law.

## NOTICE

The information contained in this document is subject to change without notice. Smart-AVI makes no warranty of any kind with regard to this material, including but not limited to, implied warranties of merchantability and fitness for any particular purpose.

Smart-AVI will not be liable for errors contained herein or for incidental or consequential damages in connection with the furnishing, performance or use of this material.

No part of this document may be photocopied, reproduced or translated into another language without prior written consent from Smart-AVI.

For more information, visit [www.smartavi.com](http://www.smartavi.com).



SmartAVI, Inc. / Twitter: smartavi  
11651 Vanowen St. North Hollywood, CA 91605  
Tel: (818) 503-6200 Fax: (818) 503-6208  
<http://www.SmartAVI.com>